

SPECIFICATION

JCB POTHOLE PRO
HYDRADIG



POTHOLE PRO

Area/day: 299y² Pothole repair: 8 minutes Repair/yd²: \$37.35



CUT. CROP. CLEAN.

The new JCB Pothole Pro is a unique 3 in 1 solution specifically designed to sort out any pothole repair or large reinstatement operations, efficiently, economically and permanently. Because it comes with 3 dedicated attachments to cut, crop and clean, there's no need for additional specialist equipment or extra manpower, saving you both time and money. And with a typical pothole repaired in 8 minutes, why compromise on a quick fix that won't last, when you can have quick and permanent? In fact, all you need to add, is the tar.

UNCOMPROMISING POTHOLE REPAIR.

Designed to work safely and efficiently in congested urban areas, the Pothole Pro prepares a pothole safely, in just 8 minutes - ready for reinstatement.



CUT FROM THE CAB.

From the cab, you can easily adjust the 24in planer, with hydraulic depth and tilt control to improve safety and maximise performance.



CROP FOR REPAIRS THAT LAST.

Maximize the life of your pothole repair with the dedicated cropping tool, which provides a uniform hole profile that lasts.



CLEAN WITH ONE MACHINE.

The 4ft wide sweeper collector with dust suppression, enables you to prepare your pothole in a matter of minutes.



LOWEST COST PERMANENT REPAIR.

You can count on the JCB Pothole Pro to sort out any pothole repair or large reinstatement operations, efficiently, economically and permanently.

STATIC DIMENSIONS

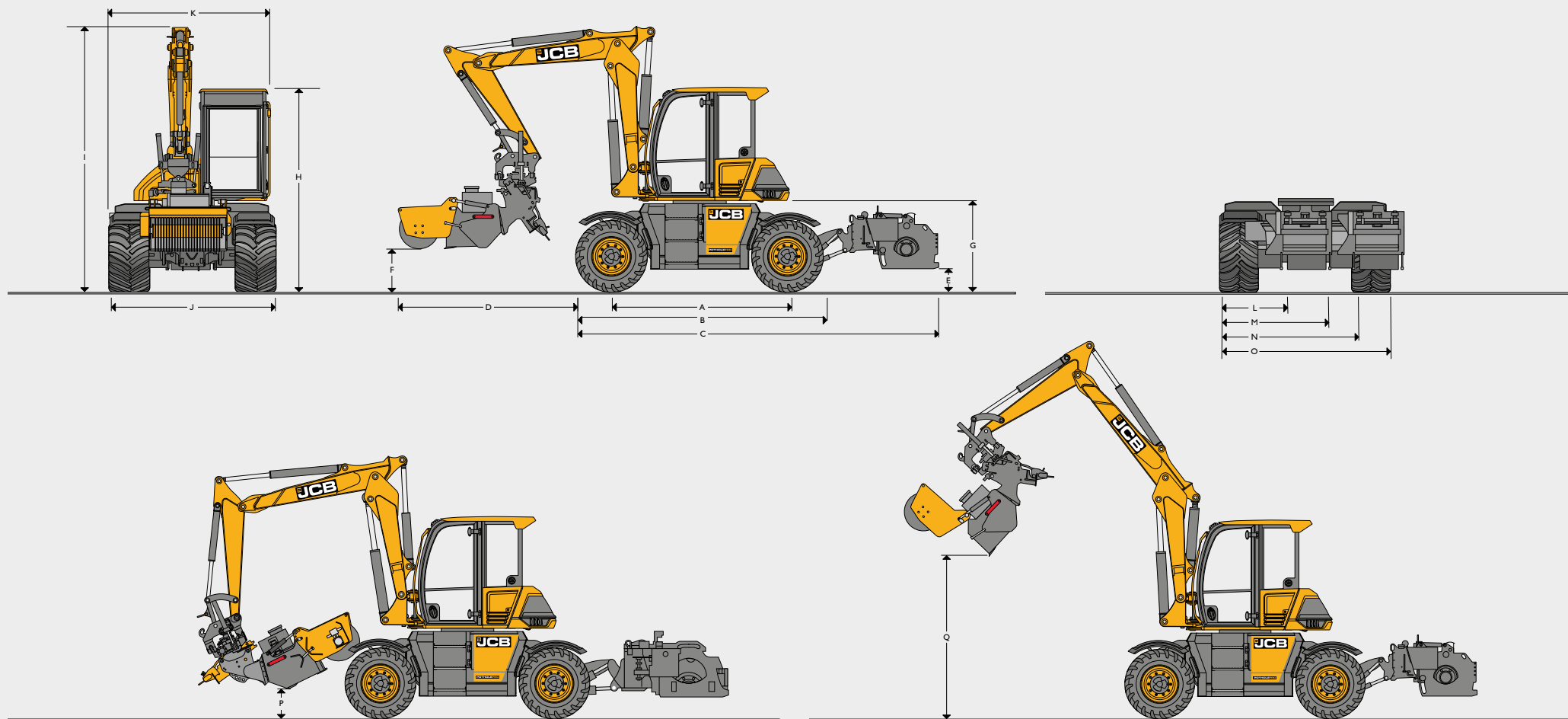

A	Wheel base	in	104
B	Length over tyres	in	148
C	Length over tyres and planer	in	216
D	Front transport length	in	90
E	Planer transport height	in	14
F	Sweeper transport height	in	18
G	Slew height	in	54
H	Cab height	in	120
I	Transport height	in	157

J	Width over tyres	in	99
	Width over tyres and cab	in	97
L	Planer max right off set	in	38
M	Planer max right offset and cut	in	62
N	Planer max left off set	in	79
O	Planer max left offset and cut	in	102
P	Ground clearance of sweeper	in	18
Q	Max dump @40 degree bucket tip	in	144

STATIC DIMENSIONS

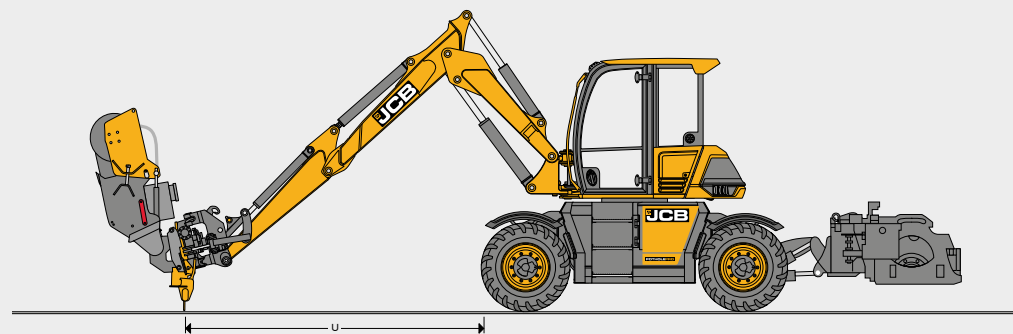
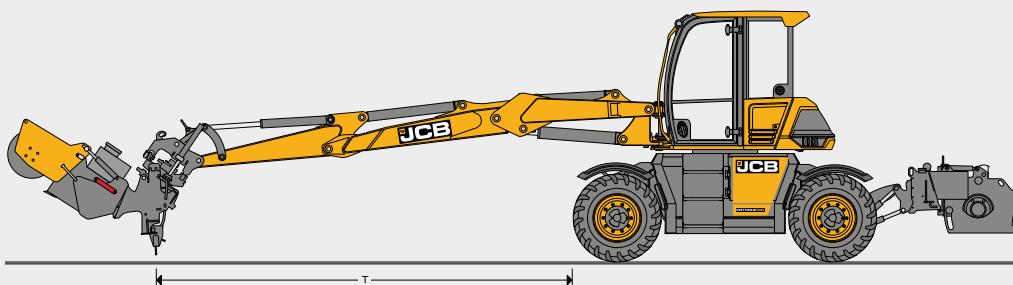
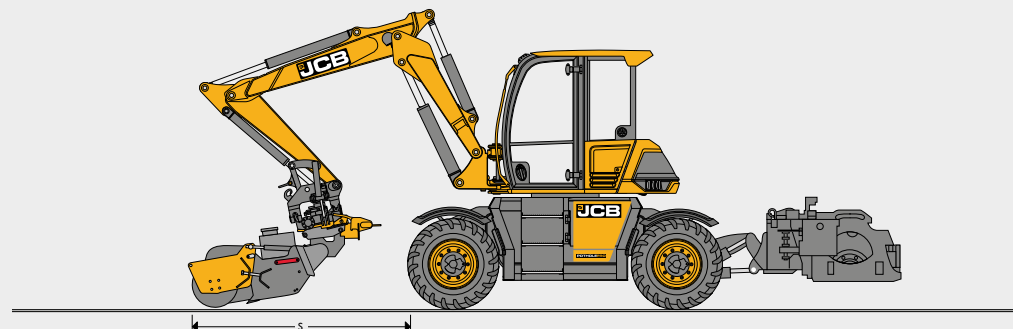
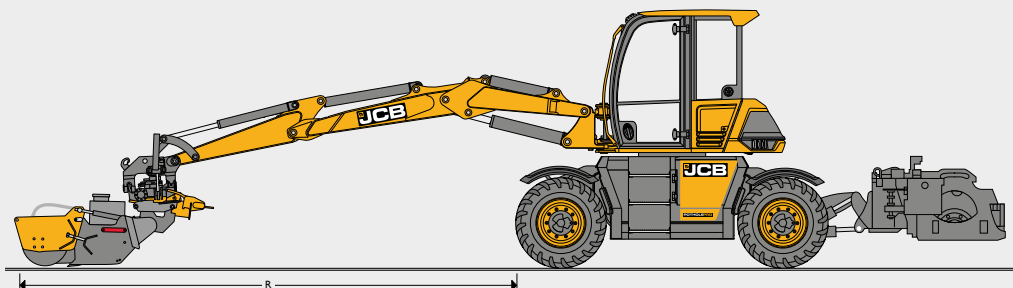

R	Max working reach with sweeper	in	261
S	Min working reach with sweeper	in	119
T	Max reach with hammer	in	202
U	Min cropping distance	in	147
V	Max ground length planing	in	216
W	Sweeper position when planing	in	295
	Max over hang with planer	in	69
	Front axle / rear axle		Oscillating steering axle / rigid steering axle
	Axles load capacity	lbs	30865
	Axles load oscillation	degrees	+/- 8
	Transmission		Hydrostatic drive via piston motor and stepless transmission

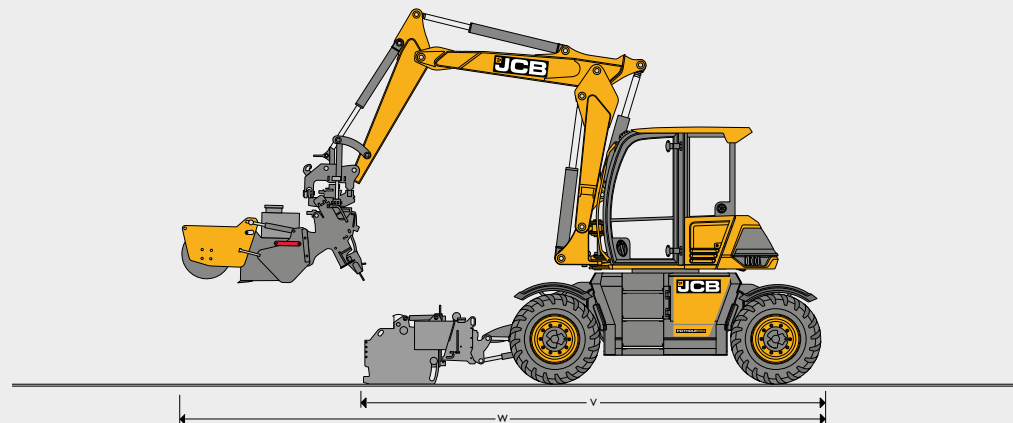

ENGINE	
Model	JCB EcoMAX 444 TCA EU Stage IV EPA Tier 4 Final compliant
Type	4-stroke, 4-cylinder in-line, common rail, direct injection, turbocharged and intercooled diesel
Rated power (ISO 14396)	109 hp (81 kW) @ 2200 rpm
Gross torque (ISO 14396)	380 lb-ft
Piston displacement	4.4 liters
Air filtration	Dry element with secondary safety element and in-cab warning sensor
Starting system	12 volt
Batteries	12 volt
Alternator	12 volt, 150 amp

MAIN HYDRAULIC SYSTEM	
System	Electronically controlled system using two variable displacement piston pumps plus twin gear pumps for steering, brakes and cooling
Services pump	72cc variable displacement axial piston pump
Flow rate @ 2200rpm	41.8 gal
Excavator main relief pressure	4060 psi
Transmission pump	85cc variable displacement axial piston pump in a closed loop hydrostatic drive system independent from working hydraulics
Flow rate @ 2200rpm	49.4 gal
Transmission absolute pressure	7614 psi
Upper high flow auxiliary	
High flow auxiliary pressure	3046 psi
High flow auxiliary max. flow	31.7 g/min
Upper low flow auxiliary	
Low flow auxiliary pressure	3046 psi
Low flow auxiliary max. flow	15.9 g/min
Second low flow auxiliary pressure	3046 psi
Second low flow auxiliary max. flow	15.9 g/min
Free line return	29 psi
Case drain line	7.25 psi
Lower high flow auxiliary	
High flow auxiliary pressure	4061 psi
High flow auxiliary max. flow	39.6 g/min
Free line return	29 psi
Case drain line	7.25 psi
QRC on all hose connections	
Hydraulic cylinders	Hardened, chromed piston rods with end damping on boom raise and dipper in
Filtration	
In tank	125 micron suction strainer
Main return line	10 micron return line filter

SLEW SYSTEM	
Slew motor	Axial piston type
Slew brake	Hydraulic braking plus automatic spring applied disc type parking brake
Slew torque	6070 lb-ft
Slew speed	8.9 rpm
Slew gear	11 tooth pinion / 84 tooth ring

TYRES	
Type	Floatation
Dimensions	600 x 40 - 22.5
Inflation pressure	6 Bar (87 Psi)
Ply/load rating	18

TURNING RADIUS	
To outside of tyre	190 in
To outer edge of planer	206.5 in

TRAVEL SPEED	
Max. roading speed	25 mph
Drawbar pull	10115 lb-ft
Steering	Fully hydraulic system with 4-wheel steer, 2-wheel steer and crab steer

BRAKES	
Brakes	All hydraulic dual circuit brake system with positive brake back off
Parking brake	Dedicated park brake disc on rear axle input
Gradability	26.6° / 50% maximum continuous, 35° (up and down) or 17° (across)

SERVICE CAPACITIES		
Fuel tank	gallons	41
Engine coolant	gallons	7
Engine oil	gallons	3
Hydraulic system	gallons	50
Hydraulic tank	gallons	34
Transmission (dropbox)	gallons	0.2
Axle differentials (each)	gallons	Front = 4, rear = 3
Axle hubs (each)	gallons	0.5
DEF fluid capacity	gallons	5

OPERATING WEIGHT		
Machine equipped with all attachments and 165 lbs operator, 339.5 lbs fuel and floatation tyres	lbs	29432

ATTACHMENTS**Cropping Tool**

HM012T hammer

15.25in as standard

Mounted on the 360 Multitool

Planer

24in planer

Mounted on a skid steer compatible hitch

Dust suppression

Tilt 8 degrees either way

Max cutting depth 6.69in

Modes: floating or powered tilt

Sideshift: 1.42yd traverse to the curb side 4.27ft

QRC on all hydraulic connections

Water drain down point included

External water filter with easy clean filter

Standard 14-way skid steer electrical connector

Sweeper Collector

Hydraulic powered brush 4ft diameter

4ft width

Hydraulic opening hood for bucket / collector mode

1.09yd cube shovel capacity

Dust suppression through twin outlet water suppression ports

QRC on all hydraulic connections

Drain down point included

External water filter with easy clean filter

Quick connect cable for water pump

POTHOLE PRO STANDARD FEATURES

Single pivot chassis

ENGINE

JCB EcoMAX 448 EU Stage V EPA compliant

4.8 liter, 109hp @ 2200rpm, 380 lb/ft torque @ 1450rpm

Start pre heat (Grid Heater)

One touch idle

Auto idle function

DOC and SCRf system

2x 12v 1000CCA Batteries

Fuel filter with water separator

Electronic engine control

Engine auto stop

Fuel cooler

SAFETY

Battery isolator

Key

JCB 2GO

Lockable fuel cap

Hydraulic cap lock

Full LED 2 x dipper 2 x boom 2 x cab front 2 x cab rear 2 x cab side

Rear camera

Fire extinguisher

ROPS and FOPS cab

Reverse alarm

Rear fog lights

Amber beacon

Full road light and mirrors

CONTROLS AND FEATURES

Side exit exhaust

25 mph transmission

Reverse steering system

Hogarth 46 hydraulic oil

4 wheel fenders

Full belly guards

JCB LiveLink

Rear trailer electrics

Smooth ride system

Cruise control

10,000 lbs lifting link

Cesar data tag

EH proportional control

Two wheel, four wheel and crab steering options

ATTACHMENTS

4 line tilt - rotator (Steelwrist)

S45 to skid steer dipper hitch 23.62in

HM120 hammer with 24in blade

24in sideshifting planer

SC120 sweeper collector shovel

CAB

Sound insulated and 4 shock mounted cab

Deluxe high back fabric air suspension seat with heated base

Height adjustable arms

Sliding window

Immobiliser

7" color display

Front up and over window with removable lower section

Dual front wiper

Media port

Rain visor

Number plate prov

Radio kit

Locking park brake

3" Hi Vis seat belt

Climate control

Momentary park brake & locking brake pedal

Travel speed indicator











Highway and site mode

Enhanced tilt-rotator controls

Rear wash wipe

Internal storage container

LIFT CAPACITIES: 5.4FT WITHOUT ATTACHMENTS TAB

Reach	9.8 ft		13.1 ft		16.4 ft		19.6 ft		Capacity at Max Reach		
											
Load Point Ht.	lbs	lbs	lbs	lbs	lbs	lbs	lbs	lbs	lbs	lbs	in
14.7ft	4027*	4027*	4640*	4640*	3895*	3134	-	-	3342*	2270	234
9.8ft	-	-	5657*	4157	4307*	2993	3333*	2244	3051*	1935	256
4.9ft	-	-	6422*	3802	4733*	2813	3582*	2167	3075*	1862	261
0ft	-	-	5932*	3721	4462*	2738	3306*	2140	2711*	2004	249
-3.2ft	6148*	6148*	4960*	3789	3736*	2769	-	-	2297*	2297*	231

 Lift capacity front and rear.

 Lift capacity full circle.

Notes:

1. For lifting capacity including bucket, subtract total weight of bucket or bucket and quickhitch from above values.
2. Lifting capacities are based on ISO 10567, that is: 75% of minimum tipping load or 87% of hydraulic lift capacity, whichever is the less. Lifting capacities marked* are based on hydraulic capacity.
3. Lift capacities assume that the machine is on firm, level ground.
4. Lift capacities may be limited by local regulations. Please refer to your dealer.

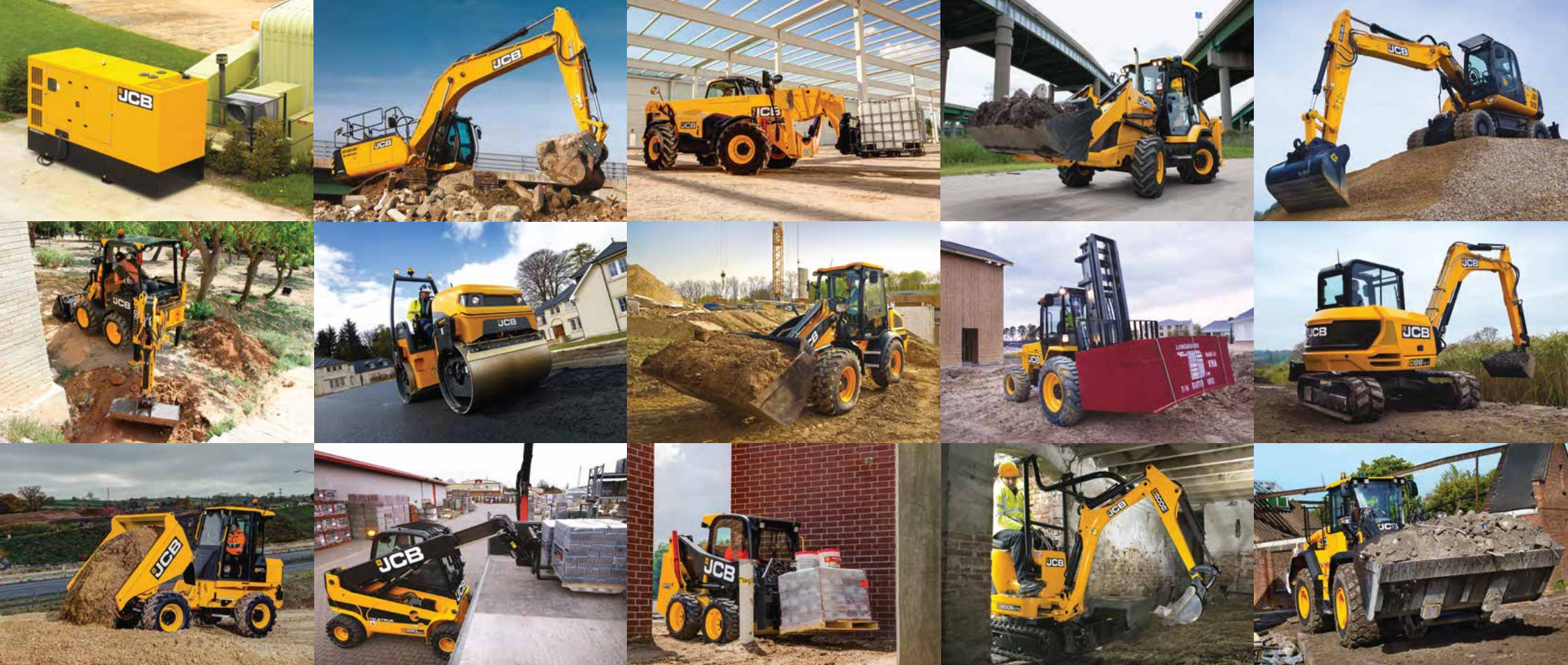

ONE COMPANY, OVER 300 MACHINES.

Your nearest JCB dealer

Pothole Pro

Area/day: 229yd² Pothole repair: 8 minutes Repair/yd² : \$37.35 Cub Yards: \$31.23

JCB North America

2000 Bamford Blvd., Pooler, Georgia, 31322 Tel: (912) 447-2000

Download the very latest information on this product range at www.jcb.com

JCB inc. All rights reserved. No part of this publication may be reproduced, stored in a retrieval system, or transmitted in any form or by any other means, electronic, mechanical, photocopying or otherwise, without prior permission from JCB inc. All references in this publication to operating weights, sizes, capacities and other performance measurements are provided for guidance only and may vary dependant upon the exact specification of machine. They should not therefore be relied upon in relation to suitability for a particular application. Guidance and advice should always be sought from your JCB Dealer. JCB reserves the right to change specifications without notice. Illustrations and specifications shown may include optional equipment and accessories. The JCB logo is a registered trademark of J C Bamford Excavators Ltd.

